

High Pressure Filter

Pi 420

Nominal pressure 400 bar (5690 psi), nominal size up to 450
optional with reverse flow valve

1. Features

High performance filters for modern hydraulic systems

- Modular system
- Compact design
- Minimal pressure drop through optimal flow design
- Visual/electrical/electronic maintenance indicator
- Threaded or flanged connections
- Equipped with highly efficient glass fibre PS filter elements
- Beta rated elements according to ISO 16889 multipass test
- Elements with high differential pressure stability and dirt holding capacity
- NPT- and SAE-connections on request
- Worldwide distribution



2. Flow rate/pressure drop curve (filter housing incl. element)

■ 190 mm²/s
■ 33 mm²/s

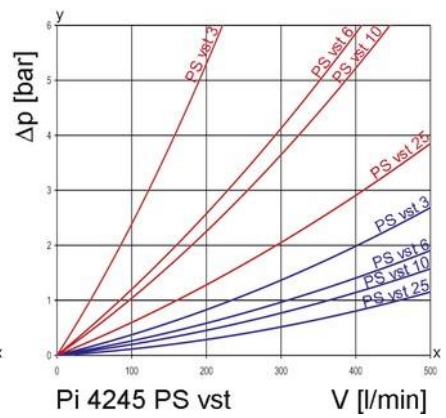
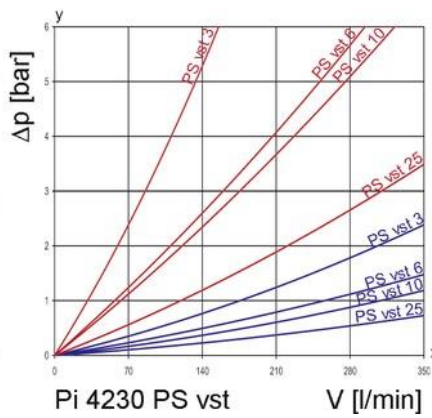
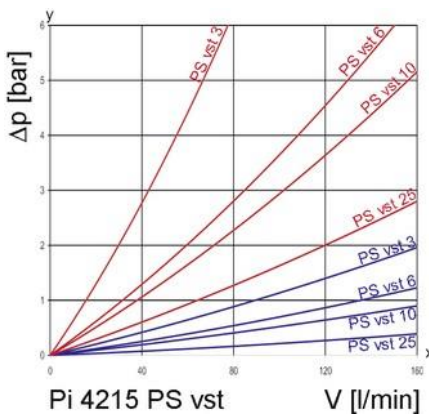
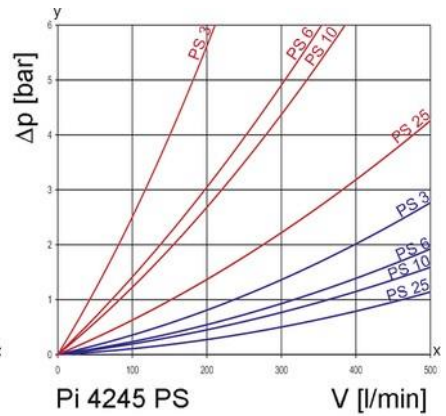
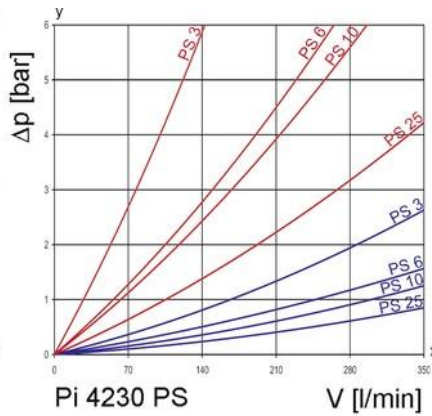
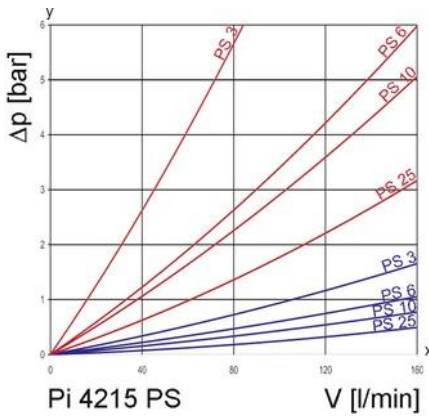
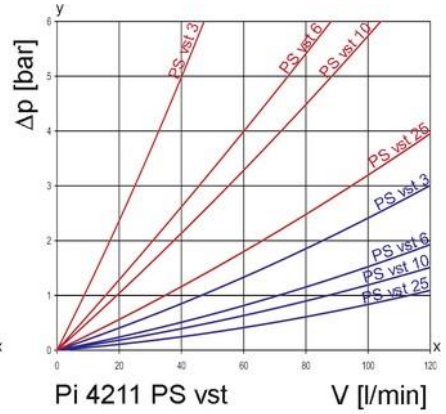
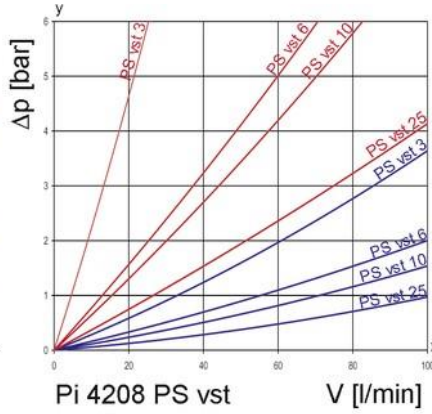
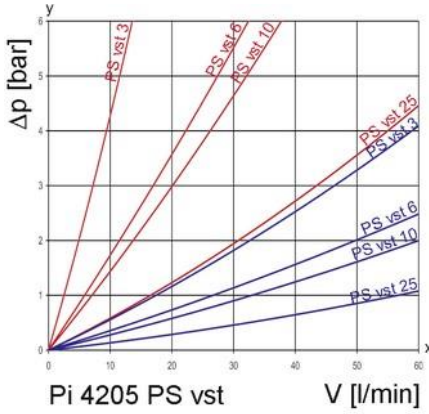
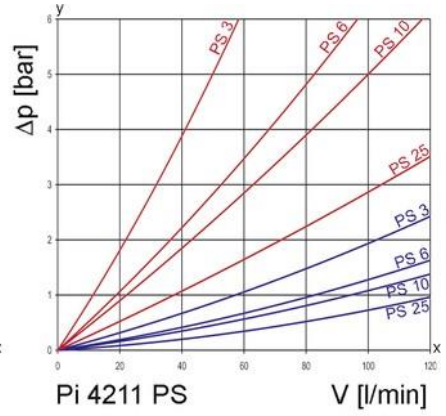
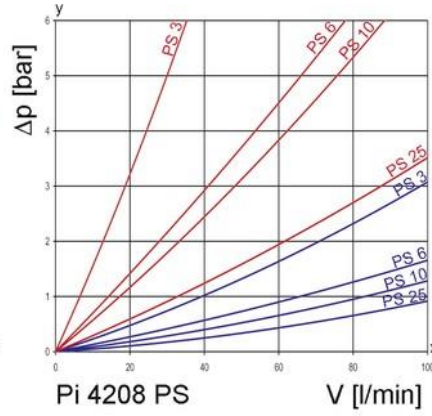
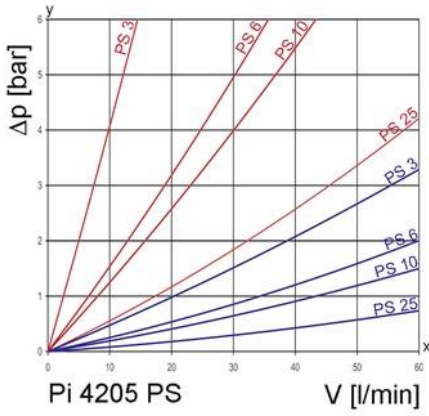

y = differential pressure Δp [bar]
 x = flow rate V [l/min]

3. Separation grade characteristics

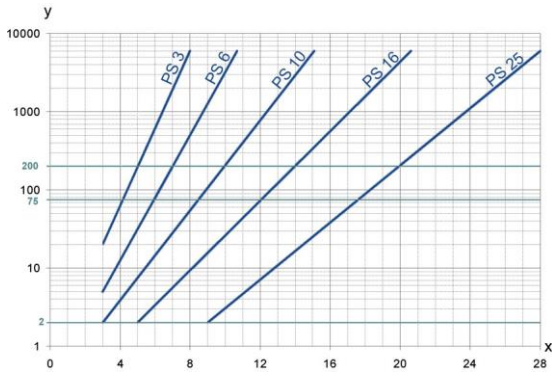

y = beta-value
x = particle-size [μm]

determined by multipass tests (ISO 16889)
calibration according to ISO 11171 (NIST)

4. Filter performance data

tested according to ISO 16889 (multipass test)

PS elements with
max. Δp 20 bar

PS 3 $\beta_{5(C)} \geq 200$
PS 6 $\beta_{7(C)} \geq 200$
PS 10 $\beta_{10(C)} \geq 200$
PS 25 $\beta_{20(C)} \geq 200$

values guaranteed up to
10 bar differential pressure

PS vst elements with
max. Δp 210 bar

PS vst 3 $\beta_{5(C)} \geq 200$
PS vst 6 $\beta_{7(C)} \geq 200$
PS vst 10 $\beta_{10(C)} \geq 200$
PS vst 25 $\beta_{20(C)} \geq 200$

values guaranteed up to
20 bar differential pressure

5. Quality assurance

FGC filters and filter elements are produced according to the following international standards:

Norm	Designation
DIN ISO 2941	Hydraulic fluid power filter elements; verification of collapse/burst resistance
DIN ISO 2942	Hydraulic fluid power filter elements; verification of fabrication integrity
DIN ISO 2943	Hydraulic fluid power filter elements; verification of material compatibility with fluids
DIN ISO 3723	Hydraulic fluid power filter elements; method for end load test
DIN ISO 3724	Hydraulic fluid power filter elements; verification of flow fatigue characteristics
ISO 3968	Hydraulic fluid power-filters-evaluation of pressure drop versus flow characteristics
ISO 10771.1	Fatigue pressure testing of metal containing envelopes in hydraulic fluid applications
ISO 16889	Hydraulic fluid power filters-multipass method for evaluation filtration performance of a filter element

6. Symbols

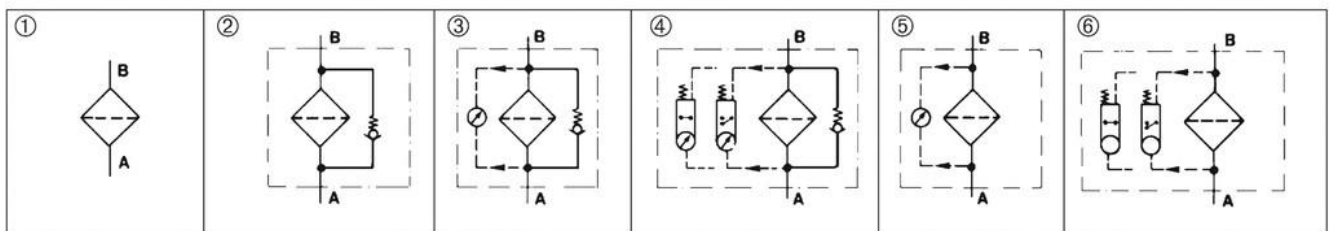

7. Order numbers

Example for ordering filters:

1. Housing design	2. Filter elements
Housing design V = 80 l/min, electrical maintenance indicator Type: Pi 4208-015 Order number: 77666472	PS vst 3 Type: Pi 2208 PS vst 3 Order number: 77680200

7.1 Housing design										
Nom- inal size NG [l/ min]	Order number thread version	Type thread version	Order number flange version	Type flange version	① with indicator cavity	② with bypass valve and indicator cavity	③ with bypass valve and visual indicator	④ with bypass valve and electrical indicator	⑤ with visual indicator	⑥ with electrical indicator
50	77666357	Pi 4205-010	77967714	Pi 4205-010 FL						
	77666365	Pi 4205-011	77967722	Pi 4205-011 FL						
	77666373	Pi 4205-012	77967730	Pi 4205-012 FL						
	77666381	Pi 4205-013	77967748	Pi 4205-013 FL						
	77666399	Pi 4205-014	77967755	Pi 4205-014 FL						
	77666415	Pi 4205-015	77967763	Pi 4205-015 FL						
80	77666423	Pi 4208-010	77967771	Pi 4208-010 FL						
	77666431	Pi 4208-011	77967789	Pi 4208-011 FL						
	77666449	Pi 4208-012	77967797	Pi 4208-012 FL						
	77666456	Pi 4208-013	77967805	Pi 4208-013 FL						
	77666464	Pi 4208-014	77967813	Pi 4208-014 FL						
	77666472	Pi 4208-015	77967821	Pi 4208-015 FL						
110	77666480	Pi 4211-010	77967839	Pi 4211-010 FL						
	77666498	Pi 4211-011	77967847	Pi 4211-011 FL						
	77666506	Pi 4211-012	77967854	Pi 4211-012 FL						
	77666514	Pi 4211-013	77967862	Pi 4211-013 FL						
	77666522	Pi 4211-014	77967870	Pi 4211-014 FL						
	77666530	Pi 4211-015	77967888	Pi 4211-015 FL						
150	77666548	Pi 4215-010	77978596	Pi 4215-010 FL						
	77666555	Pi 4215-011	77978604	Pi 4215-011 FL						
	77666563	Pi 4215-012	77978612	Pi 4215-012 FL						
	77666571	Pi 4215-013	77978620	Pi 4215-013 FL						
	77666589	Pi 4215-014	77978638	Pi 4215-014 FL						
	77666597	Pi 4215-015	77978646	Pi 4215-015 FL						
300	77666613	Pi 4230-010	77978653	Pi 4230-010 FL						
	77666621	Pi 4230-011	77978661	Pi 4230-011 FL						
	77666639	Pi 4230-012	77978679	Pi 4230-012 FL						
	77666647	Pi 4230-013	77978687	Pi 4230-013 FL						
	77666654	Pi 4230-014	77978695	Pi 4230-014 FL						
	77666662	Pi 4230-015	77964505	Pi 4230-015 FL						
450	77666688	Pi 4245-010	77978703	Pi 4245-010 FL						
	77666696	Pi 4245-011	77978711	Pi 4245-011 FL						
	77666704	Pi 4245-012	77978729	Pi 4245-012 FL						
	77666712	Pi 4245-013	77978737	Pi 4245-013 FL						
	77666720	Pi 4245-014	77978745	Pi 4245-014 FL						
	77666746	Pi 4245-015	77978752	Pi 4245-015 FL						

When filter with non bypass configuration is selected, the collapse pressure of the element must not be exceeded.

7.2 Filter elements (a wider range of element types is available on request)

Nominal size NG [l/min]	Order number	Type	Filter material	max. Δp [bar]	Filter surface [cm ²]
50	77680135	Pi 2105 PS 3	PS 3	20	590
	77943509	Pi 5105 PS 6	PS 6		590
	77680325	Pi 3105 PS 10	PS 10		590
	77680440	Pi 4105 PS 25	PS 25		590
	77680192	Pi 2205 PS vst 3	PS vst 3	210	425
	77943533	Pi 5205 PS vst 6	PS vst 6		425
	77680382	Pi 3205 PS vst 10	PS vst 10		425
	77680507	Pi 4205 PS vst 25	PS vst 25		425
80	77680143	Pi 2108 PS 3	PS 3	20	1150
	77943517	Pi 5108 PS 6	PS 6		1150
	77680341	Pi 3108 PS 10	PS 10		1150
	77680457	Pi 4108 PS 25	PS 25		1150
	77680200	Pi 2208 PS vst 3	PS vst 3	210	850
	77943541	Pi 5208 PS vst 6	PS vst 6		850
	77681190	Pi 3208 PS vst 10	PS vst 10		850
	77680515	Pi 4208 PS vst 25	PS vst 25		850
110	77680150	Pi 2111 PS 3	PS 3	20	1700
	77943525	Pi 5111 PS 6	PS 6		1700
	77680333	Pi 3111 PS 10	PS 10		1700
	77680465	Pi 4111 PS 25	PS 25		1700
	77680218	Pi 2211 PS vst 3	PS vst 3	210	1275
	77943558	Pi 5211 PS vst 6	PS vst 6		1275
	77680390	Pi 3211 PS vst 10	PS vst 10		1275
	77680523	Pi 4211 PS vst 25	PS vst 25		1275
150	77680168	Pi 2115 PS 3	PS 3	20	2425
	77955099	Pi 5115 PS 6	PS 6		2425
	77680358	Pi 3115 PS 10	PS 10		2425
	77680473	Pi 4115 PS 25	PS 25		2425
	77680226	Pi 2215 PS vst 3	PS vst 3	210	2010
	77955123	Pi 5215 PS vst 6	PS vst 6		2010
	77680408	Pi 3215 PS vst 10	PS vst 10		2010
	77680531	Pi 4215 PS vst 25	PS vst 25		2010
300	77680176	Pi 2130 PS 3	PS 3	20	4620
	77955107	Pi 5130 PS 6	PS 6		4620
	77680366	Pi 3130 PS 10	PS 10		4620
	77680481	Pi 4130 PS 25	PS 25		4620
	77680234	Pi 2230 PS vst 3	PS vst 3	210	3800
	77955131	Pi 5230 PS vst 6	PS vst 6		3800
	77680416	Pi 3230 PS vst 10	PS vst 10		3800
	77680549	Pi 4230 PS vst 25	PS vst 25		3800
450	77680184	Pi 2145 PS 3	PS 3	20	6865
	77955115	Pi 5145 PS 6	PS 6		6865
	77680374	Pi 3145 PS 10	PS 10		6865
	77680499	Pi 4145 PS 25	PS 25		6865
	77680242	Pi 2245 PS vst 3	PS vst 3	210	5600
	77955149	Pi 5245 PS vst 6	PS vst 6		5600
	77680424	Pi 3245 PS vst 10	PS vst 10		5600
	77680556	Pi 4245 PS vst 25	PS vst 25		5600

8. Technical specifications

Design:	line mounting filter
Nominal pressure:	400 bar (5690 psi)
Test pressure:	520 bar (7400 psi)
Temperature range:	-10 °C to +120 °C (other temperature ranges on request)
Bypass setting:	Δp 7 bar \pm 10 %
Filter head material:	GGG
Filter housing material:	St
Sealing material:	NBR/PTFE
Maintenance indicator setting:	Δp 5 bar \pm 10 %
Electrical data of maintenance indicator:	
Maximum voltage:	250 V AC/200 V DC
Maximum current:	1 A
Contact load:	70 W
Type of protection:	IP 65 in inserted and secured status
Contact:	normally open/closed
Cable connection:	M20x1.5

The switching function can be changed by turning the electric upper part by 180° (normally closed contact or normally open contact). The state on delivery is a normally closed contact. By inductivity in the direct current circuit the use of suitable protection circuit should be considered. Further maintenance indicator details and designs are available in the maintenance indicator data sheet.

We draw attention to the fact that all values indicated are average values which do not always occur in specific cases of application. Our products are continually being further developed. Values, dimensions and weights can change as a result of this. Our specialized department will be pleased to offer you advice.

We recommend to contact us concerning applications of our filters in areas governed by the EU Directive 94/9 EG (ATEX 95). The standard version can be used for liquids based on mineral oil (corresponding to the fluids in Group 2 of Directive 97/23 EG Article 9). If you consider to use other fluids please contact us for additional support.

Subject to technical alteration.

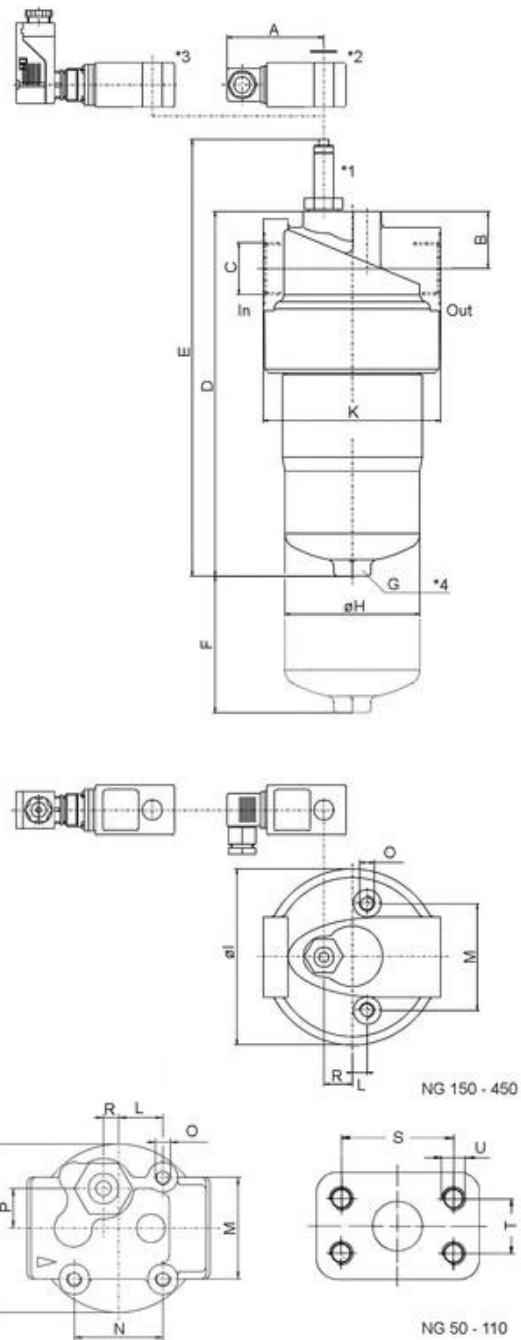

- In = Inlet
- Out = Outlet
- *1 = Visual maintenance indicator
- *2 = Electrical upper section connector according DIN EN 175301-803, version: PiS 3092, 3105, 3115
- *3 = Electrical upper section connector according DIN EN 175301-804, version: PiS3102, 3122, 3110
- *4 = NG 300, 450 with drain screw G $\frac{1}{4}$ DIN910

DN25 according to SAE1" 6000 psi
 DN38 according to SAE1½" 6000 psi
 Flange, screw, o-ring not included in delivery.

9. Dimensions

All dimensions except "C" in mm.

Type	A	B	C*	D	E	F	G SW	H	I	K
Pi 4205	78	31	G½	189	247	80	27	66	90	92.0
Pi 4205 FL		28	DN25	204	262				85	95.0
Pi 4208	78	31	G1	267	325	80	27	66	90	92.0
Pi 4208 FL		28	DN25	282	340				85	95.0
Pi 4211	78	31	G1	343	401	80	27	66	90	92.0
Pi 4211 FL		28	DN25	358	416				85	95.0
Pi 4215	78	46	G1¼	284	342	110	30	109	142	143.5
Pi 4215 FL			DN38							
Pi 4230	78	46	G1¼	409	467	110	30	109	142	143.5
Pi 4230 FL			DN38							
Pi 4245	78	46	G1½	525	583	110	30	109	142	143.5
Pi 4245 FL			DN38							

* NPT- und SAE-connections on request

Type	L	M	N	O	P	R	S	T	U	Weight [kg]
Pi 4205	23.5	54	47	M8x14	21	8	57.1	27.8	M12x20	4.1
Pi 4205 FL	10.5		-			12				4.6
Pi 4208	23.5	54	47	M8x14	21	8	57.1	27.8	M12x20	4.9
Pi 4208 FL	10.5		-			12				5.3
Pi 4211	23.5	54	47	M8x14	21	8	57.1	27.8	M12x20	5.8
Pi 4211 FL	10.5		-			12				6.2
Pi 4215	12.0	86	-	M12x15	-	23	79.4	36.5	M16x20	12.3
Pi 4215 FL										13.3
Pi 4230	12.0	86	-	M12x15	-	23	79.4	36.5	M16x20	14.8
Pi 4230 FL										15.9
Pi 4245	12.0	86	-	M12x15	-	23	79.4	36.5	M16x20	17.1
Pi 4245 FL										18.6

10. Execution with reverse flow valve

Filters are normally designed for single-direction flow only. Reverse flows result in destruction of the cartridge. Some applications can require the medium to flow through the filter in both directions, however. The Pi 420 with a reverse flow valve can be used here. It allows medium flows in both directions, although it only filters in one. The liquid is not filtered in reverse mode. The reverse flow valve can be supplied with or without a bypass function.

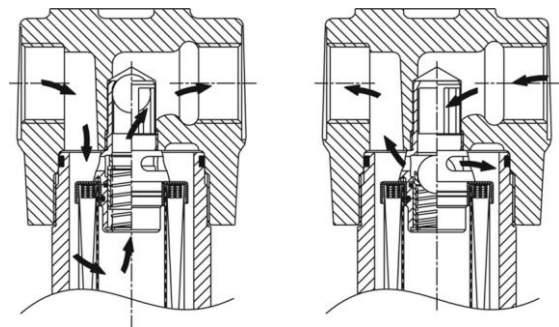

Filtration mode

Reverse mode

11. Installation, operating and maintenance instructions

11.1 Filter installation

When installing the filter make sure that sufficient space is available to remove filter element and filter housing. Preferably the filter should be installed with the filter housing pointing downwards.

The maintenance indicator must be visible.

11.2 Connecting the electrical maintenance indicator

The electrical indicator is connected via a 2-pole appliance plug according to DIN EN 175301-803 with poles marked 1 and 2.

The electrical section can be inverted to change from normally open position to normally closed position or vice versa.

11.3 When should the filter element be replaced?

- Filters equipped with visual and electrical maintenance indicator:
During cold starts, the indicator may give a warning signal. Press the red button of the visual indicator once again only after operating temperature has been reached. If the red button immediately pops up again and/or the electrical signal has not switched off after reaching operating temperature, the filter element must be replaced after the end of the shift.
- Filters without maintenance indicator:
The filter element should be replaced after the trial run or flushing of the system. Afterwards follow instructions of the manufacturer.
- Please always ensure that you have original FGC spare elements in stock: Disposable elements (PS) cannot be cleaned.

11.4 Element replacement

- Stop system and relieve filter from pressure.
- Filter sizes 300 and 450: empty the filter housing by removing the drain plug.
- Unscrew the filter housing by turning counter-clockwise. Clean the housing using a suitable cleaning solvent.
- Remove element by pulling down carefully.
- Check o-ring, spigot and o-ring in the element locator for damage. Replace, if necessary.
- Make sure that the order number on the spare element corresponds to the order number of the filter name-plate. To ensure no contamination occurs during the exchange of the element first open the plastic bag and push the element over the spigot in the filter head. Now remove plastic bag.
- Oil the threads of the filter housing a little bit and screw into the filter head. Maximum tightening torque for NG 50 to 110 = 60 Nm, for NG 150 to 450 = 100 Nm.
- Check seals of vent drain plug - if necessary, please replace.
Torque drain plug 30 Nm.

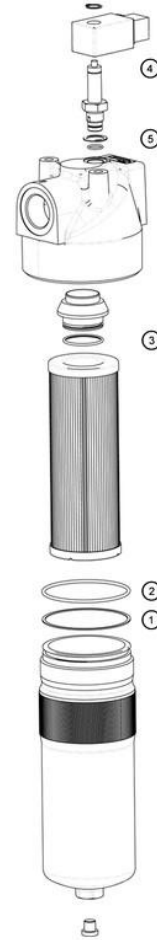

12. Spare parts list

Order numbers for spare parts		
Position	Type	Order number
① to ③	Seal kit	
	Pi 4205 - Pi 4211	
	NBR	77544851
	FPM	77544869
	EPDM	77544877
	Pi 4215 - Pi 4245	
	NBR	77544885
	FPM	77544893
	EPDM	77544901
④	Maintenance indicator	
	Visual PiS 3093/5	77669914
	Electrical PiS 3092/5	77669864
	Electrical upper section only	77536550
⑤	Seal kit for maintenance indicator	
	NBR	77760275
	FPM	77760283
	EPDM	77760291

Filtration Group GmbH
Schleifbachweg 45
D-74613 Öhringen
Phone +49 7941 6466-0
Fax +49 7941 6466-429
industrial.sales@filtrationgroup.com
industrial.filtrationgroup.com
78356990.04/2021

High Pressure Filter Pi 420 up to NG 450